

M10545

INSTALLATION INSTRUCTIONS SHEET

START FROM HERE

- Make sure power is completely off at the fuse box.
- Have your fixture installed by a qualified licensed electrician
- Prepare everything in clear area.
- Wear gloves at all times during this installation.
- Read instructions carefully before you start assembly.
- Keep this instruction sheet for future reference.

Technical Support: 1-844-628-8368

Please Note:

- All Matteo Lighting fixtures come with pre-wired module(s).
- Unless instructed to do so, please do not touch any part of the module(s) as unnecessary contact with the module could cause permanent damage.

THIS LUMINAIRE MUST BE MOUNTED OR SUPPORTED IN A JUNCTION BOX
*CE LUMINAIRE DOIT ÊTRE MONTÉ OU SUPPORTÉ DANS UNE BOÎTE
DE JONCTION*

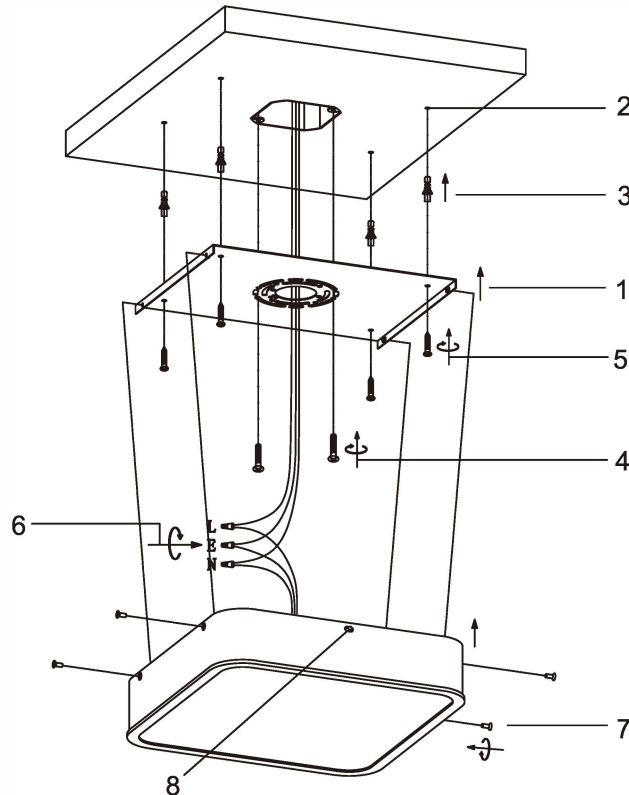

- Ensure main supply is switched off
- Put the mounting plate on the junction box at the right position and mark the $\varnothing 5$ holes on the ceiling then put the mounting plate off (1)
- Drill a hole on the ceiling at the mark of the $\varnothing 5$ holes(2)
- Install the bolts into the holes (3)
- Use machine screw to fix the mounting plate onto junction box (4)
- Use self-tapping screw to tight it (5)
- Connect wires according to colour (White to White, Black to Black). Connect all earth lug together onto the crossbar with green screw to tight (6)
- Use M4 screws to fix the canopy on the mounting plate (7)
- Use the switch to choose the colour temperature you want (8)
- Reconnect power.
- Lamping: AC LED 120V 30W CRI90, triac dimming, 3CCT: 3000K/4000K/5000K optional

WARNING:

- This fitting must be earthed.
- Disconnect power and allow fitting to cool down before cleaning or changing the lamp.